

No.	Name	Note	No.	Name	Note
1	Angle valve	1/4"Flare	13	Refrigerant service valve	1/4"Flare
2	Discharge flange	3"	14	Connector	1/4"Flare
3	Solenoid valve	50%(NC)	15	Liquid injection connector	5/8"Flare, option
4	Solenoid valve	75%(NC)	16	Suction flange	4"
5	Solenoid valve	25%(NC)	17	Cable box	Standard
6	Liquid(oil or refrigerant) injection connector	3/8"Flare, option	18	Service flange	
7	Capillary		19	Oil drain valve	option
8	Check valve	3"	20	Discharge temp. sensor	110°C
9	Service flange		21	Safety Valve	option
10	Stop Pin		22	Economizer port	7/8", solder
11	Oil inlet connector	5/8"Flare	23	Solenoid valve	Stepless(NO), option
12	Angle valve	1/4"Flare			

*All stop valves are optional

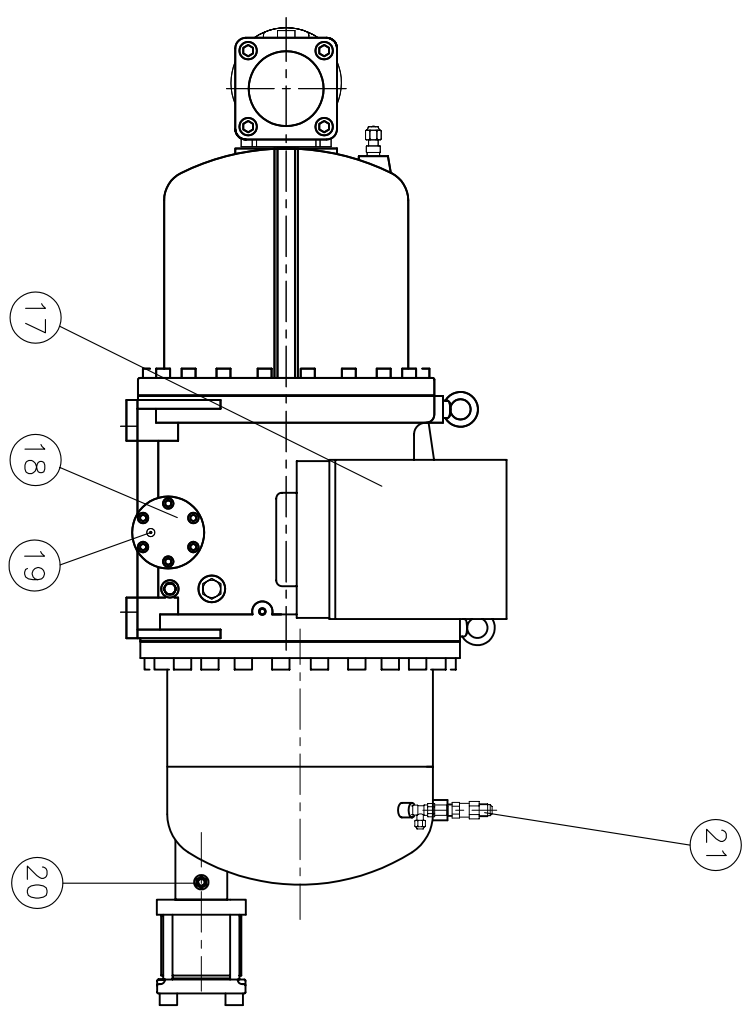

RC17F
Compressor Outline

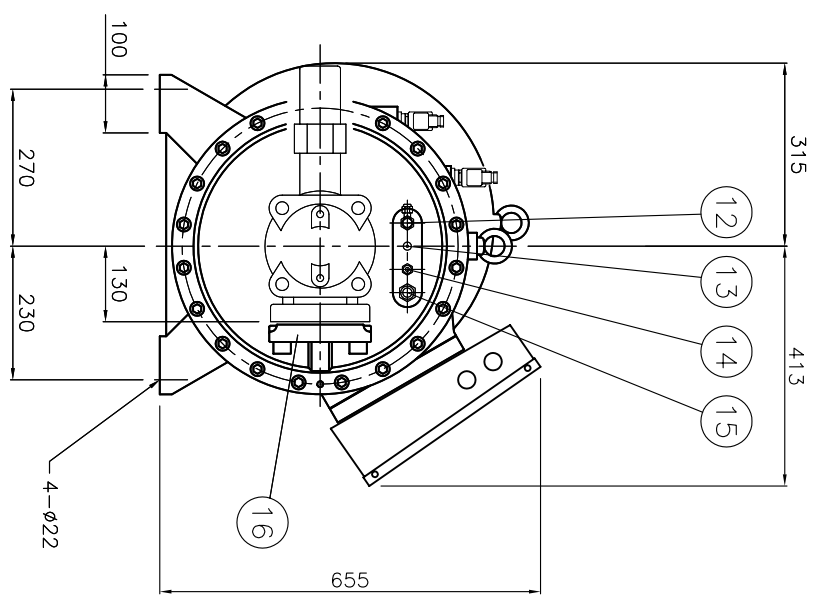
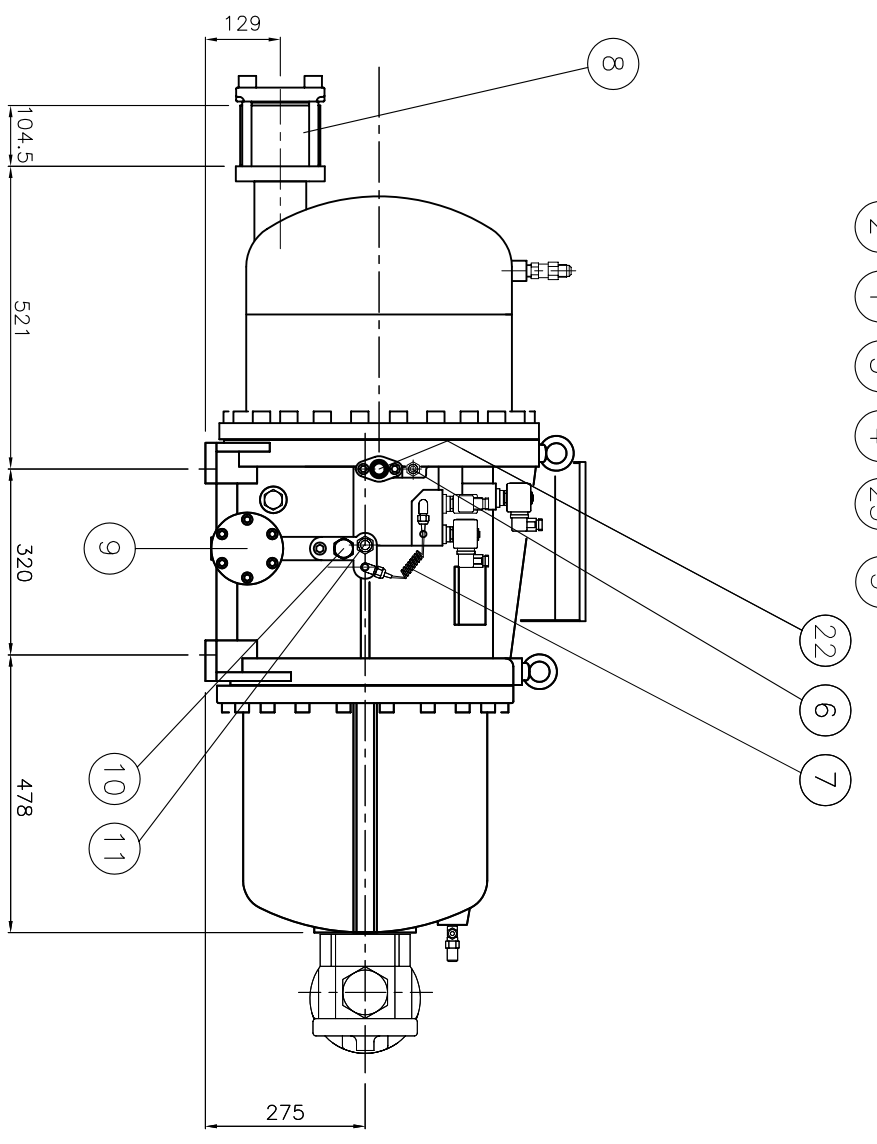
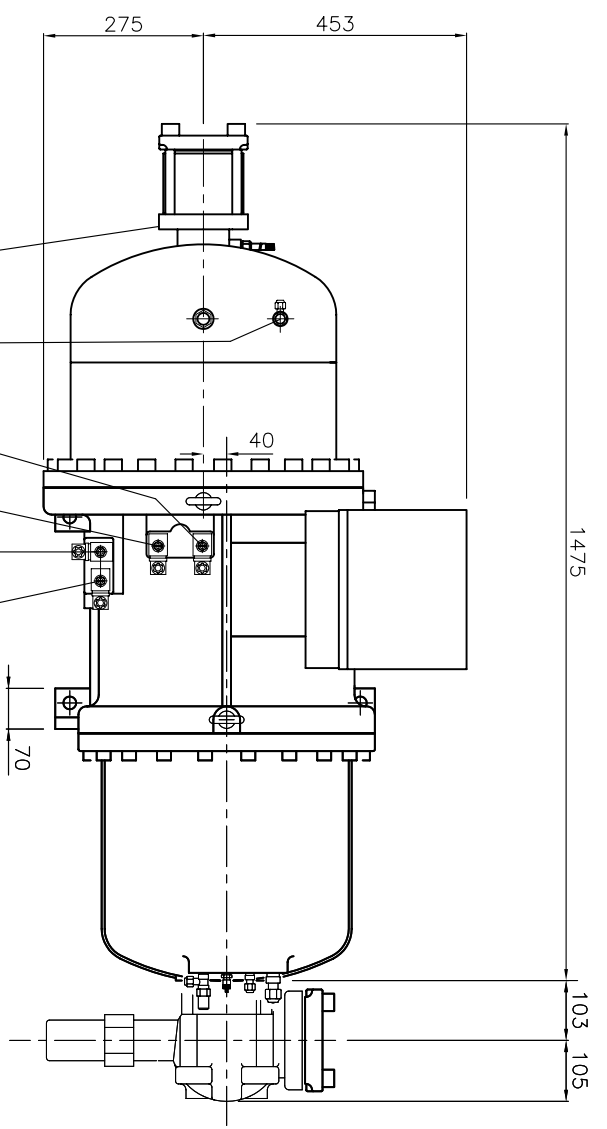