

No.	Name	Note	No.	Name	Note
1	Suction flange	8"	12	Refrigerant service valve	1/4"Flare
2	Discharge flange	5"	13	Angle valve	1/4"Flare
3	Oil connector	1/4"Flare	14	Angel valve	1/4"Flare
4	Oil connector	3/8"Flare	15	Refrigerant service valve	1/4"Flare
5	Economizer port	2 1/8", solder	16	Cable box	
6	Oil injection connector	5/8"Flare	17	Modulation control oil connector	1/4"Flare
7	Solenoid valve	Stepless(NO), option	18	Economizer flange(in)	2 1/2"
8	Solenoid valve	25%(NC)	19	Economizer flange(out)	4"
9	Solenoid valve	75%(NC)	20	Level switch	option
10	Solenoid valve	50%(NC)	21	Sight glass	
11	Liquid injection connector	1/2"Flare	22	Discharge temp. sensor	110°C

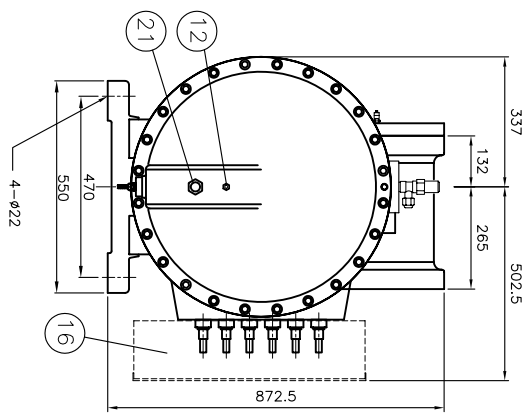

RC24
Compressor Outline

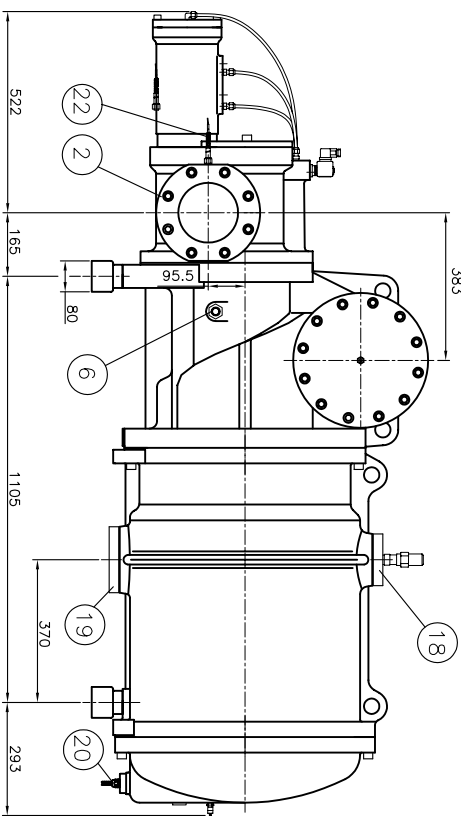